



Drawing	: - TPC 388
Issue	: - 10
Date	: - 24/11/16

DD900
10521GR-US – 460V / 3PH / 60HZ

INDUSTRIAL DEHUMIDIFIER

OWNER'S MANUAL

www.eipl.co.uk



Drawing	: - TPC 388
Issue	: - 10
Date	: - 24/11/16

DD900

PACKAGE CONTENTS

Item	Description	Quantity
10521GR-US	Dehumidifier	1
TPC388	Manual	1

UNPACKING

Carefully remove the DD900 dehumidifier unit from its transit box and visually check for signs of transit damage. If there is evidence of damage DO NOT attempt to operate the unit, call your supplier for advice. Do not discard the packing, it will be useful when transporting the dehumidifier unit in the future.

INTRODUCTION

Dehumidifiers remove moisture from the air that is circulating through the unit. The resulting reduction of relative humidity helps prevent rust, rot, mould, mildew and condensation within the room, or other enclosed spaces where the dehumidifier is used.

The DD900 is of the desiccant wheel type designed to dry air by passing a large volume of air, the “process” air through a slowly rotating Silica gel rotor. Silica gel is a hygroscopic material that absorbs moisture direct from the air. As the air passes through the rotor the humidity of the air is reduced, whilst the moisture content of the rotor is increased. A smaller volume of air, the reactivation air, is heated by an internal heater and passes through a portion of the rotor in the opposite direction. As this heated air passes through the rotor it will “reactivate” it by removing the moisture content from the silica gel material. The reactivation air will leave the humidifier as warm, moist air and must be vented to outside of the building.

Continuous circulation of the room air through the dehumidifier unit gradually reduces the relative humidity in the room.

The DD900 dehumidifier is a robust, compact unit designed to control the humidity in the enclosed space in which it is placed. The casing is fabricated from Steel then painted and has been designed for the exacting conditions which can prevail in offices, shops, houses, restaurants, public houses etc. It combines lightness and compactness with high reliability and strength

The unit is thermally protected and will automatically switch off in excessive or abnormal conditions.

The dehumidifier has two separate filters. One in the “process” air inlet and one in the “reactivation” air inlet, used to clean the air entering the dehumidifier.



Drawing	: - TPC 388
Issue	: - 10
Date	: - 24/11/16

SPECIFICATIONS

MODEL:	DD900
HEIGHT:	1219mm (48")
WIDTH:	711mm (28")
DEPTH:	584mm (23")
WEIGHT:	95 Kg (209 lbs)
POWER SUPPLY:	460V, 3 ph, 60Hz
POWER	9.8 kW (max)
F1 CONTROLS FUSE	2A 250V 5x20 Cartridge fuse
PROCESS AIRFLOW MAXIMUM:	1500m ³ /hr (883 cfm)
PROCESS AIRFLOW NOMINAL:	900m ³ /hr (530 cfm)
REGENERATION AIRFLOW NOMINAL:	250m ³ /hr (147 cfm)
PROCESS AIR OUTLET DIA:	200mm (8")
REGENERATION AIR OUTLET DIA:	150mm (6")
ROTOR WHEEL SPEED:	13.6 (RPH)
ROTOR SIZE DIA X DEPTH:	450mm (17.7") x 100mm (3.9")
HIGH EXTRACTION SETTING @ 27 °C 60% RH:	172 l/day (364 ppd)
HIGH EFFICIENCY SETTING @ 27 °C 60% RH:	135 l/day (286 ppd)
DEEP DRYING SETTING @ 27 °C 60% RH:	153 l/day (323 ppd)
TYPICAL DRY AIR OFF HIGH EXTRACTION SETTING (%RH)	12
TYPICAL DRY AIR OFF HIGH EFFICIENCY SETTING (%RH)	14
TYPICAL DRY AIR OFF DEEP DRYING SETTING (%RH)	6
MINIMUM OPERATING TEMPERATURE:	-20 °C (-4 °F)
MAXIMUM OPERATING TEMPERATURE	40 °C (104 °F)

UNIT CAPACITY

The ambient conditions of the area to be dehumidified will determine the amount of water extraction the unit is cable of.
 Measure the ambient conditions of the area to be determined and then use that information with the following capacity diagram to determine the unit capacity.

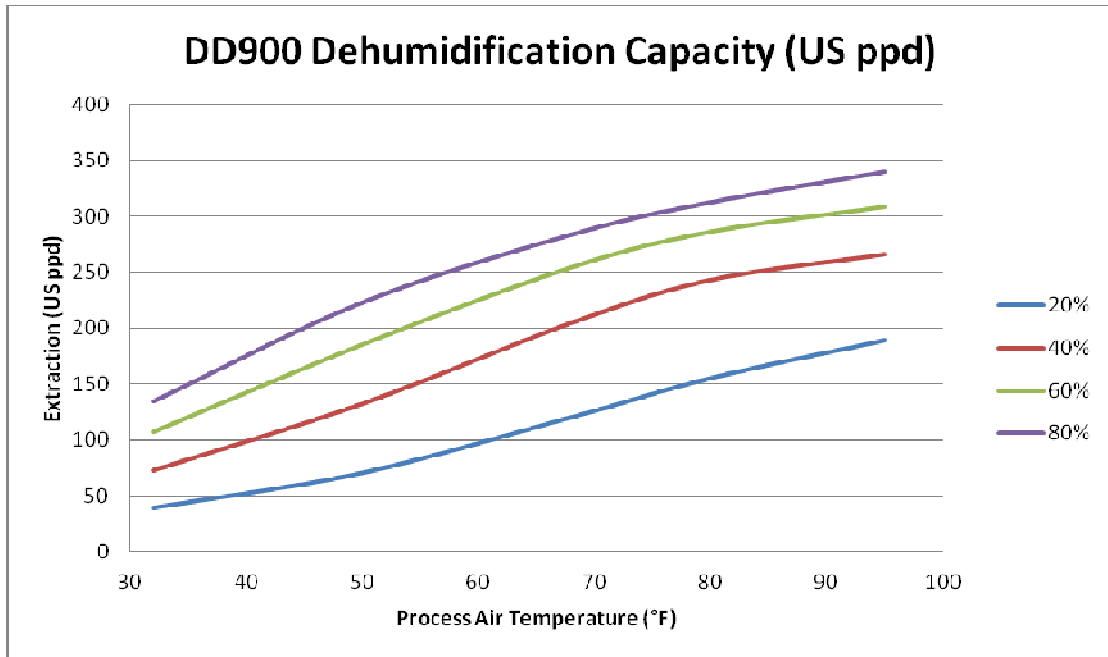

INSTALLATION

The DD900 is designed for indoor use. The unit should be placed on a level surface and a space of 1 meter free around all faces to allow access for any duct work and servicing.

Connecting duct work:

The regeneration outlet must be ducted to outside the area being dehumidified. The outlet duct spigot is 6" diameter and only 6" ducting or greater should be attached.

The process outlet can be ducted to a specific area or another room. The outlet duct spigot is 8" diameter and only 8" ducting or greater should be attached.

Power Supply & Humidistat Control:

The unit must be connected to a suitable 460V, 3 phase, 60Hz supply.

-WARNING-
THIS APPLIANCE MUST BE EARTHED

Feed power cables through the gland provided and then wire the unit as shown below.

An external humidistat can also be used to control the relative humidity in the dehumidified area. If a humidistat is used then the wires should pass through the gland provided and then wired as shown in the diagram at the back of this manual.

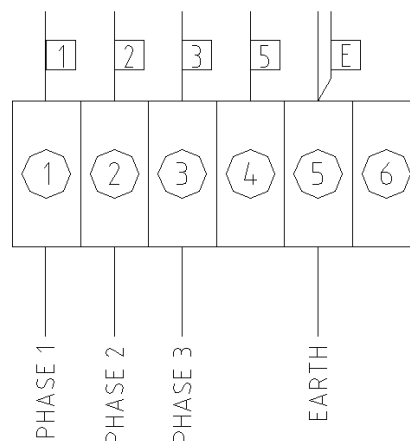

Control Settings

Once the unit is positioned correctly, required duct work attached and the power supply connected, the fan speeds and temperature control need to be set correctly.

The fan speed controls are located behind a removable cover, to the right of the main controls. The controls are numbered 1 to 10, with 10 being the maximum speed.

The temperature control regulates the temperature of the reactivation airflow onto the desiccant wheel. The control can be set up to a maximum of 145°C. To adjust the temperature control simply press the 'SET' button and then select the required setting by using the ▲ or ▼ buttons. To confirm press the ✓ button and the value is stored. The display will revert back to the current temperature.

For normal (efficient) operation the process airflow should be set to 530cfm, and the regeneration airflow set to 147cfm. Measurements should be taken at the duct outlets using a suitable instrument. The temperature setting should be set to 90°C above the ambient temperature of the area being dehumidified.

If high moisture extraction is required it will be necessary to increase both the process and regeneration airflows. The temperature control setting should also be increased.

If very low humidity levels are required then the process airflow should be reduced.

The following table should be used as a guide:

	PROCESS AIR FLOW (M³/H)	REGEN AIR FLOW (M³/H)	TEMPERATURE RISE (K)
STANDARD (EFFICIENT)	530	147	90
HIGH EXTRACTION	647	206	110
DEEP DRYING (LOW RH)	412	206	110

FAN PERFORMANCE CURVES

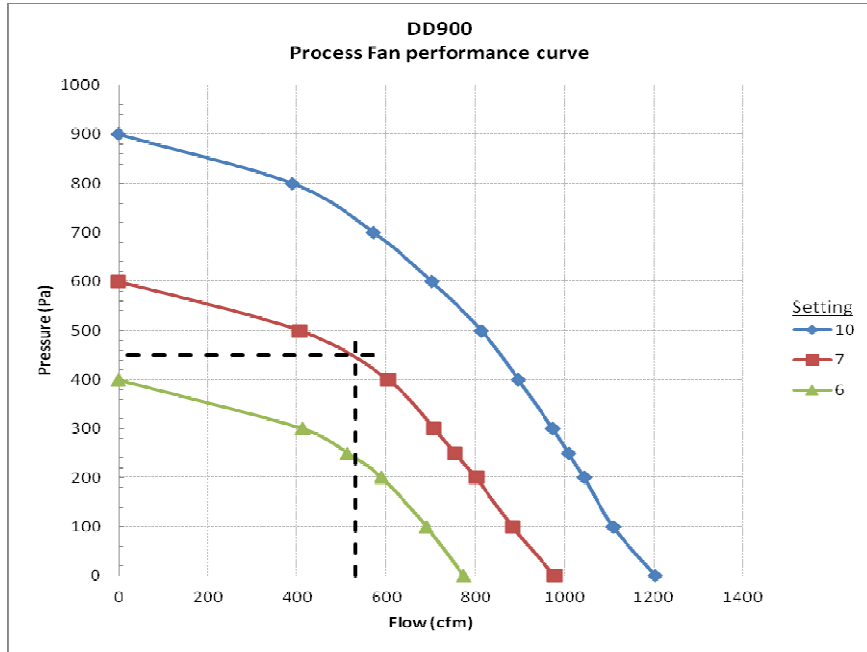

For example:

If the total system resistance is 450pa then the process fan selector would have to be set to No 7 to achieve the required airflow of 530 cfm

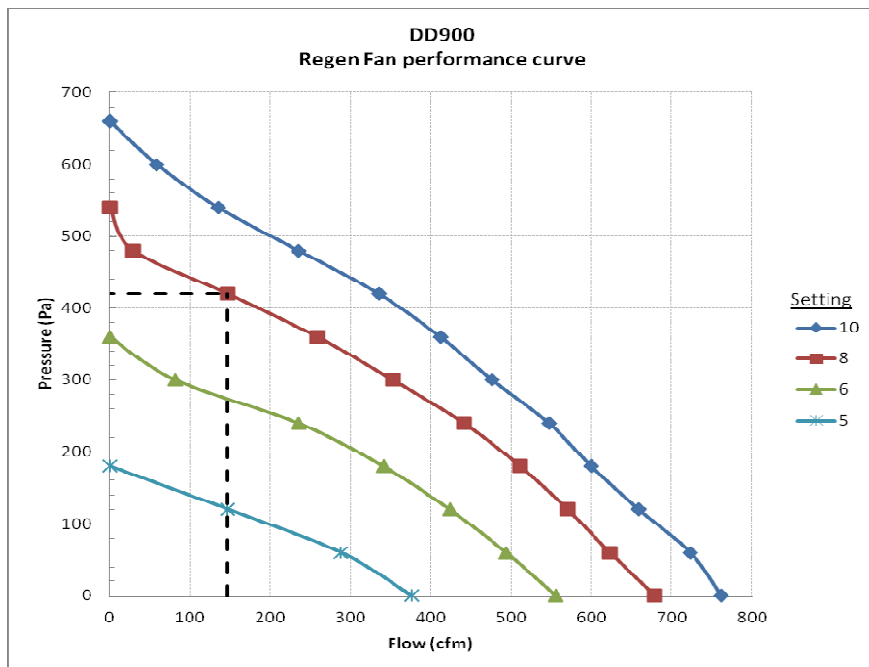

For example:

If the total system resistance is 420pa then the regen fan selector would have to be set to No 8 to achieve the required airflow of 147 cfm

OPERATION

The electrical controls are located on the front of the unit. They are:

- On / Off Switch

M	Dehumidifier in continuous operation
A	Dehumidifier operation by means of an external humidistat
0	Dehumidifier OFF

- An hour counter is provided to display the total time the unit has been in operation
- DRYING lamp – unit is in drying mode.
- HEATING lamp – indicates heating elements are on. Cycle on/off when in drying mode.
- FAULT lamp – unit has a fault

To start the dehumidifier, turn the On / Off switch to position M.

After a slight delay the fans will operate – air can be felt blowing from the air outlets and the heater will come on.

The unit will operate continuously at this setting.

If an external humidistat control is fitted, turn the unit to switch to position A. Depending on the setting of the humidistat, the dehumidifier may switch off as the relative humidity in the room decreases. As the humidity increase the unit will automatically switch back on.

High Temperature Cut-Out:

The DD900 dehumidifier has been designed to work in ambient conditions of -4°F to +104°F. Should the temperature in the room become excessive a manual overheat protector will operate, switching off the heaters. The fans and drive motor will continue to operate but the fault lamp will illuminate. Prior to resetting the protector, check that the dehumidifier is installed correctly and the ambient temperature does not exceed 104°F.

See repairs section for details on resetting device.

SAFETY

-WARNING-

- ◆ **DO NOT** ALLOW CHILDREN TO PLAY WITH OR AROUND THE UNIT. ENSURE THE UNIT IS INACCESSIBLE TO CHILDREN WHEN NOT ATTENDED.
- ◆ **DO NOT** USE THIS UNIT IN AN ENVIRONMENT CONTAINING FLAMMABLE FUMES
- ◆ **DO NOT** USE THIS UNIT IF THE CABINET OR POWER CORD IS DAMAGED
- ◆ **DO NOT** INSERT OBJECTS INTO ANY OF THE GRILLES ON THE MACHINE
- ◆ **DO NOT** COVER OR OBSTRUCT AIRFLOW FROM THE GRILLES
- ◆ **DO NOT** OPERATE THE UNIT WITH THE COVERS REMOVED
- ◆ **DO NOT** ATTEMPT ANY REPAIRS SHOULD THE UNIT FAIL TO OPERATE
- ◆ **DO NOT** STAND ON THE UNIT
- ◆ **DO NOT** LIFT THE UNIT WHEN SWITCHED ON
- ◆ **DO** CHECK THE PLUG ON THE EQUIPMENT MATCHES THE SUPPLY
- ◆ **DO** USE THE UNIT FOR THE PURPOSE FOR WHICH IT WAS DESIGNED
- ◆ **DO** ENSURE THE POWER CORD AND SUPPLY IS EARTHED CORRECTLY
- ◆ **DO** USE A RESIDUAL CURRENT DEVICE "RCD" WHERE POSSIBLE
- ◆ **DO** KEEP THE UNIT DRY. NEVER USE A HOSE OR PRESSURE WASHER TO CLEAN THE UNIT.

ROUTINE SERVICE & REPAIR

WARNING:

ENSURE THAT THE POWER CORD TO THE MACHINE HAS BEEN DISCONNECTED BEFORE CARRYING OUT ROUTINE SERVICE. THE SERVICING AND REPAIR OF THIS UNIT SHOULD ONLY BE CARRIED OUT BY A SUITABLY QUALIFIED PERSON.

SWITCH OFF THE DEHUMIDIFIER APPROXIMATELY 15 MINUTES PRIOR TO REMOVING ANY PANELS, ALLOWING THE HEATER TO COOL DOWN

To ensure continued full efficiency of the dehumidifier, maintenance procedures should be performed as follows:

- We recommend that the filters are checked at least once a month. Intervals for cleaning or replacement of filters will depend on the installation
- Never operate the dehumidifier without the filters, as the rotor can be damaged by dust.

To carryout the following, it is necessary to remove the side panels.

This machine should be serviced by qualified Ebac Industrial Products Ltd personnel or other persons having technical competence in servicing electrical equipment following the instructions in this Service Manual.

- The rotor is maintenance free. However, should it be necessary to clean the rotor, compressed air should be used to carefully blow dirt from the rotor.
- The heaters are maintenance free. However should it be necessary to clean the heaters, compressed air should be used to carefully blow dirt from the heaters.
- Check that the fans are firmly secured and that the fan rotates freely.
- Check all wiring connections.
- Check the belt tensioning at regular intervals.
- The overheat protector is located inside the unit, below the desiccant wheel. To reset this device press the red button.
- Should an electrical component fail, consult the Factory Service Center to obtain the proper replacement part.

IF ANY OF THE PRECEDING PROBLEMS OCCUR, CONTACT THE EBAC INDUSTRIAL PRODUCTS LTD SERVICE CENTER PRIOR TO CONTINUED OPERATION OF THE UNIT TO PREVENT PERMANENT DAMAGE.

TROUBLESHOOTING

<u>SYMPTOM</u>	<u>CAUSE</u>	<u>REMEDY</u>
Little or no dehumidification capacity	Filter clogged No regeneration heat Reduced airflow No rotation of Rotor Air leakage	Clean or replace filters Check Heaters / OHP Check fans / duct Check belt tension / drive motor Check sealing
Dehumidifier does not start	No power Correct switch setting Loose electrical wiring	Check fuse Check Auto / Manual switch Check wiring diagram - fault find & repair
Rotor does not rotate	Drive belt slipping Drive belt broken Rotor jammed Drive motor faulty	Check belt tension Replace drive belt Check centre shaft, rim of rotor Check supply /Replace motor
No Dry or Wet Air Airflow	Filter clogged Fan faulty Ducts blocked	Clean or replace filters Check supply / fan Check duct for obstruction
Noisy	Fan loose Loose fastenings	Check fans secured firmly Tighten all fastenings



Drawing	: - TPC 388
Issue	: - 10
Date	: - 24/11/16

WARNINGS

This appliance can be used by children from 8 years and above and persons with reduced physical, sensory or mental capabilities or lack of experience and knowledge if they have been given supervision or instruction concerning use of the application in a safe way and understand the hazards involved.

Children shall not play with the appliance.

Cleaning and user maintenance shall not be made by children without supervision.

If the SUPPLY CORD is damaged, it must be replaced by the manufacturer, its service agent or similarly qualified person in order to avoid hazard.



Drawing	: - TPC 388
Issue	: - 10
Date	: - 24/11/16



Drawing	: - TPC 388
Issue	: - 10
Date	: - 24/11/16



Drawing	: - TPC 388
Issue	: - 10
Date	: - 24/11/16

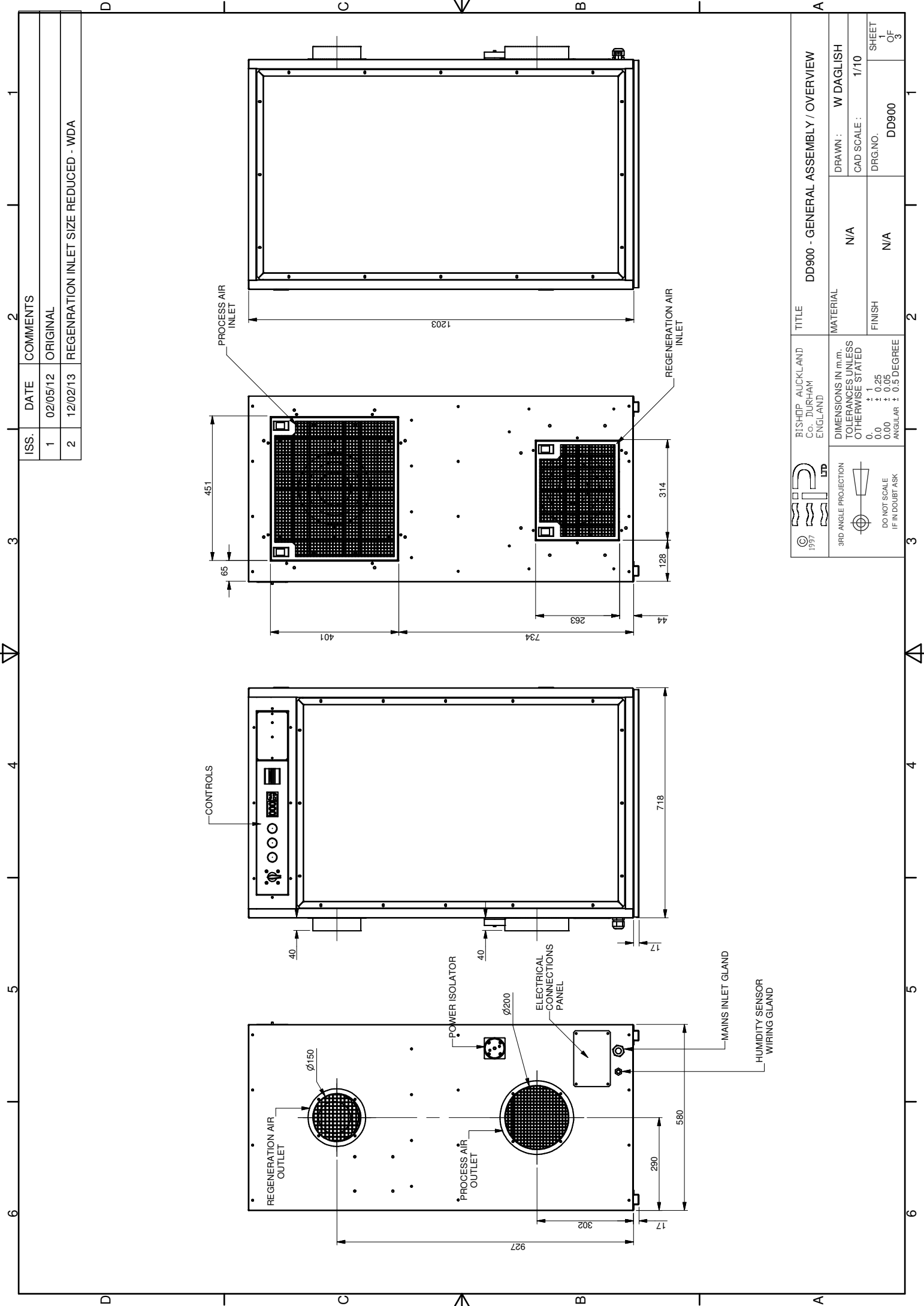

ISS.	DATE	COMMENTS
1	02/05/12	ORIGINAL
2	12/02/13	REGENERATION INLET SIZE REDUCED - WDA

TITLE		DD900 - GENERAL ASSEMBLY / OVERVIEW	
BISHOP AUCKLAND Co. DURHAM ENGLAND		MATERIAL	N/A
DIMENSIONS IN m.m. TOLERANCES UNLESS OTHERWISE STATED		DRAWN :	W DAGLISH
0	+ 1	CAD SCALE :	1/10
0.0	+ 0.25	DRG.NO.	DD900
0.00	+ 0.05	FINISH	N/A
ANGULAR	+ 0.5 DEGREE	SHEET	OF
			3

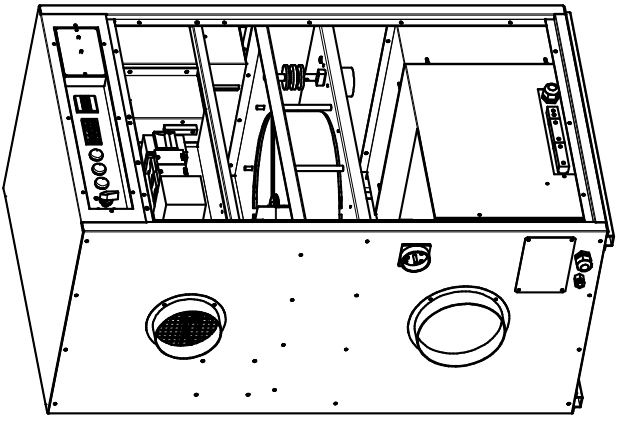
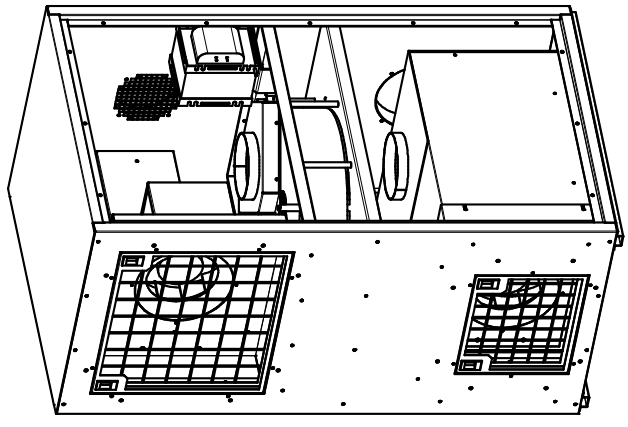
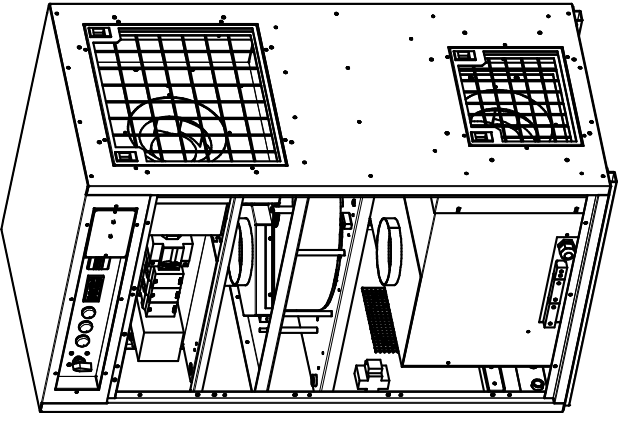
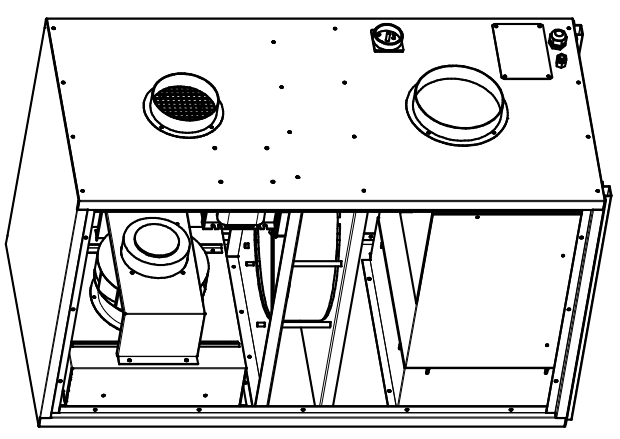
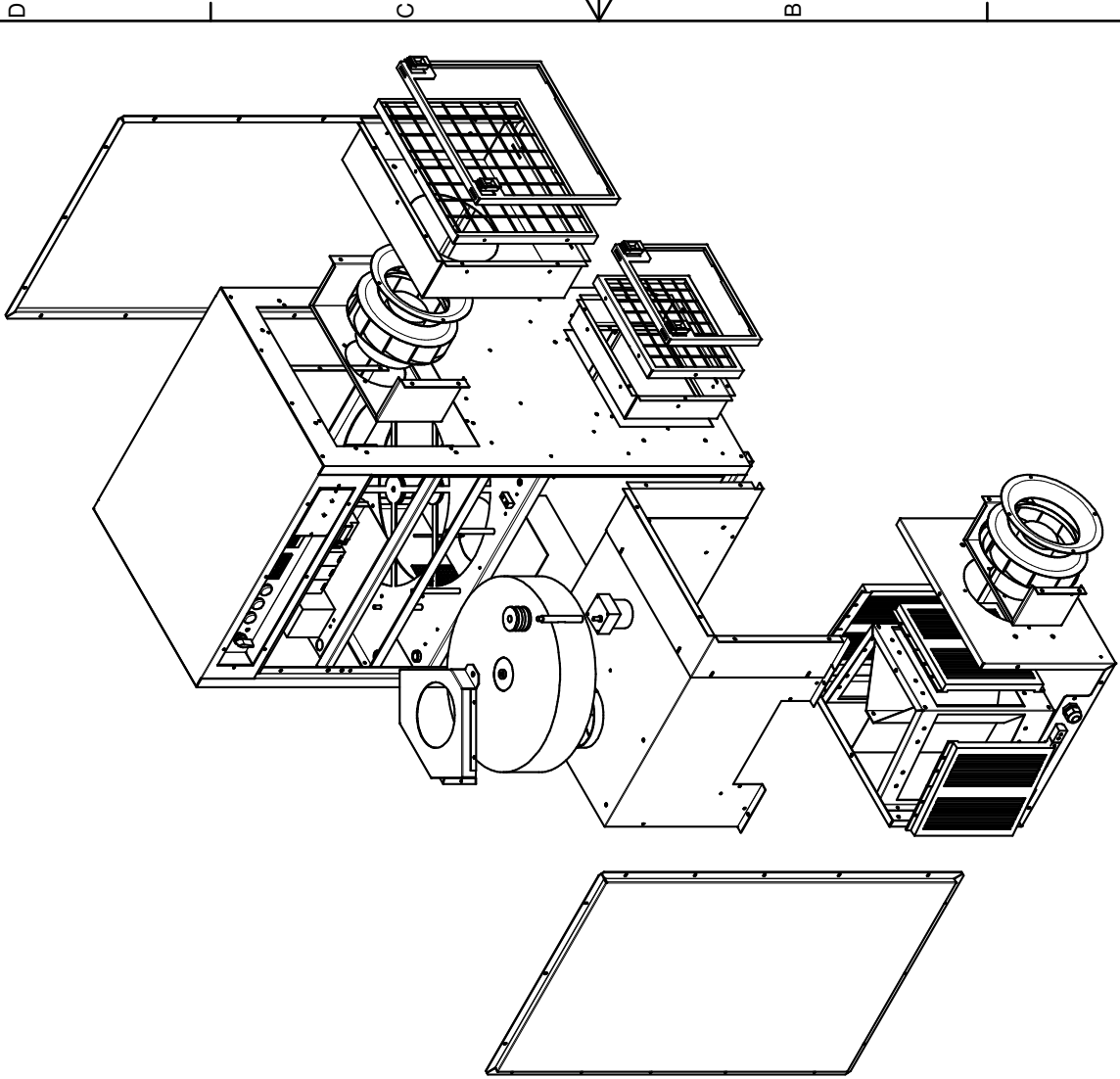

ISS.	DATE	COMMENTS
1	02/05/12	ORIGINAL
2	12/02/13	REGENERATION INLET SIZE REDUCED - WDA

BISHOP AUCKLAND Co. DURHAM ENGLAND		DD900 - GENERAL ASSEMBLY / OVERVIEW	
DIMENSIONS IN m.m. TOLERANCES UNLESS OTHERWISE STATED		MATERIAL	N/A
0	+ 1	FINISH	N/A
0.0	+ 0.25		
0.00	+ 0.05	DRG.NO.	DD900
ANGULAR	+ 0.5 DEGREE	DRAWN :	W DAGLISH
3RD ANGLE PROJECTION		CAD SCALE :	1/12
DO NOT SCALE IF IN DOUBT ASK		SHEET	
		2	
		3	

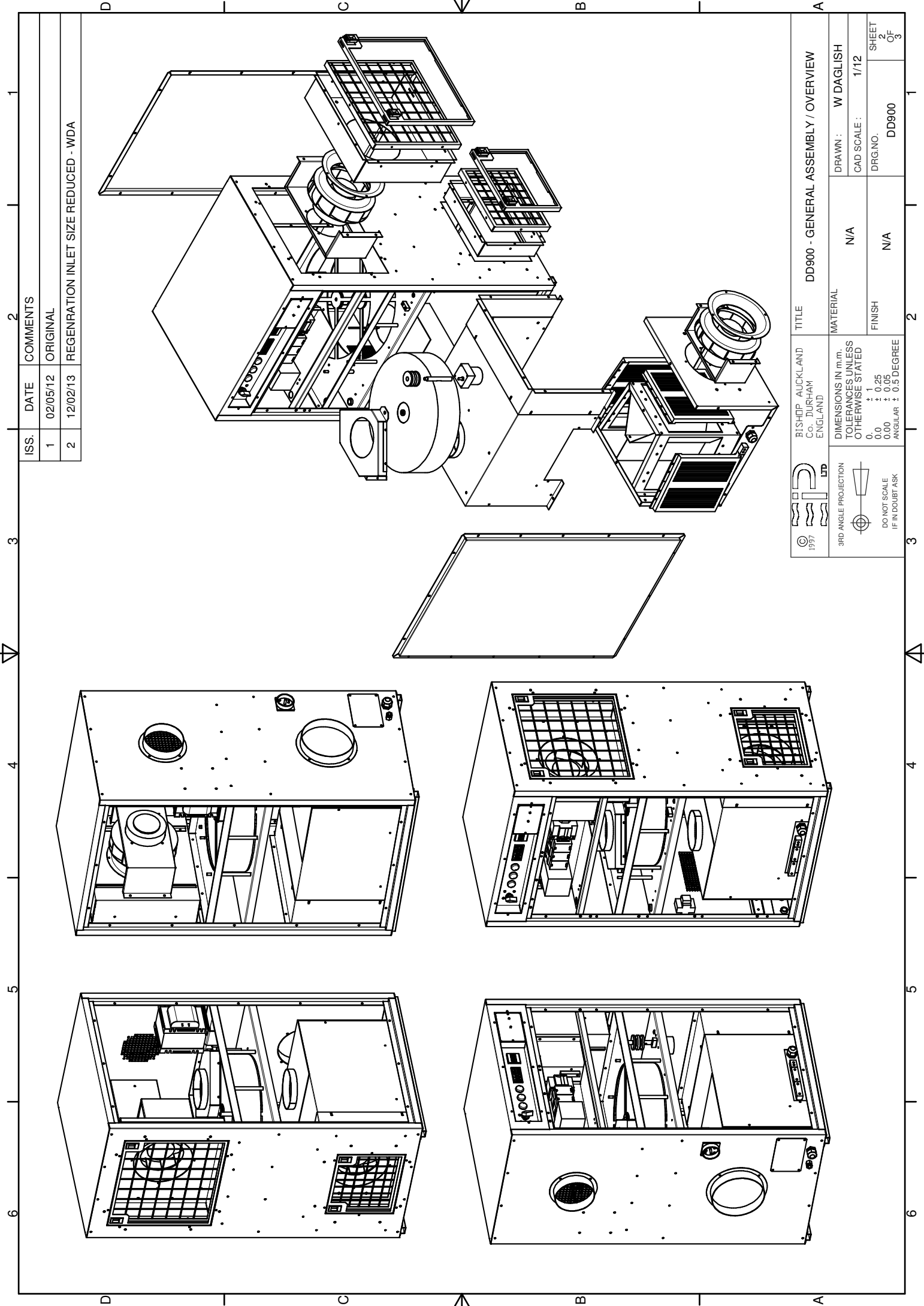

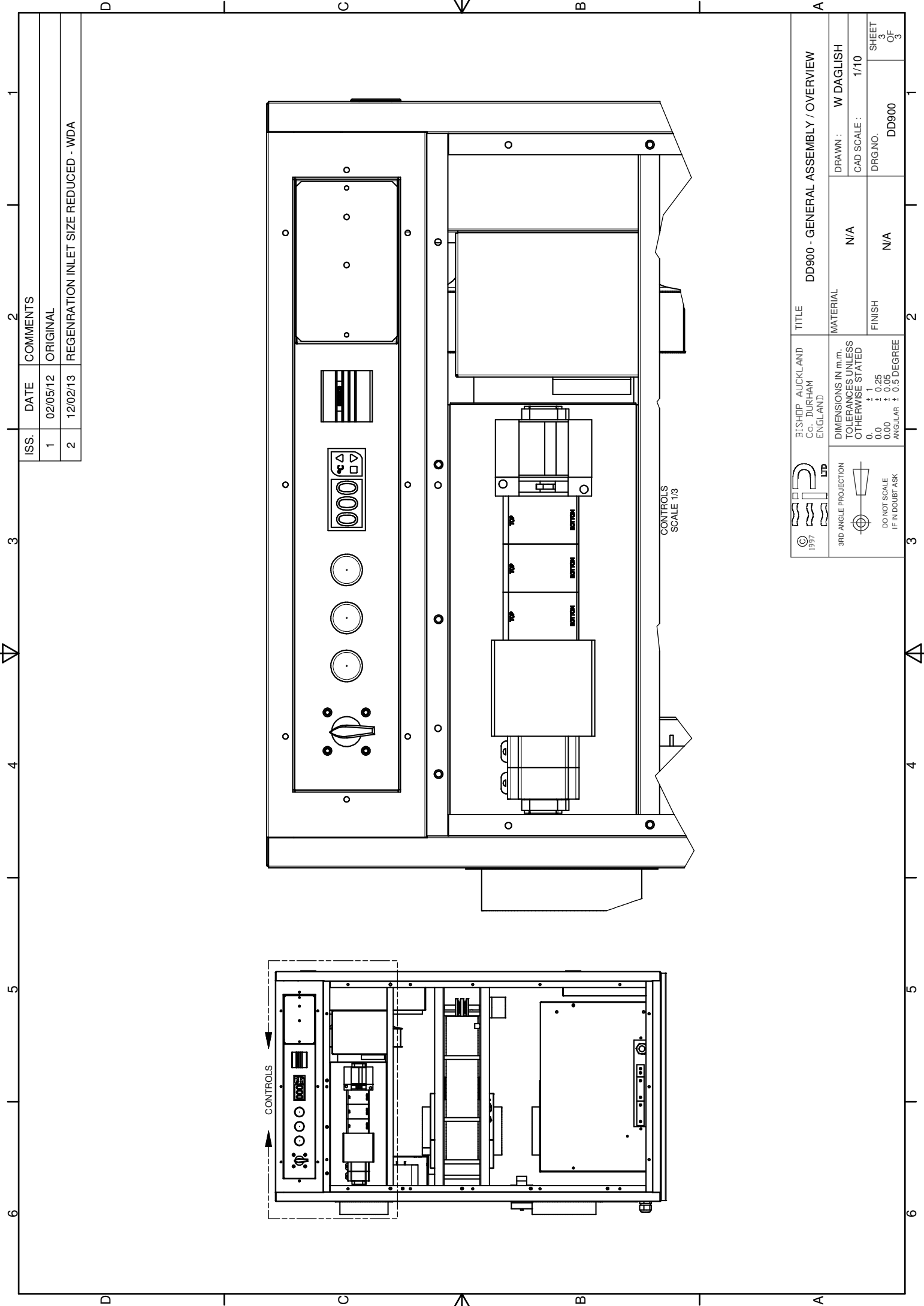

ISS.	DATE	COMMENTS
1	02/05/12	ORIGINAL
2	12/02/13	REGENERATION INLET SIZE REDUCED - WDA

BISHOP AUCKLAND Co. DURHAM ENGLAND		DD900 - GENERAL ASSEMBLY / OVERVIEW	
DIMENSIONS IN m.m. TOLERANCES UNLESS OTHERWISE STATED		MATERIAL	N/A
0	+ 1	FINISH	N/A
0.0	+ 0.25		
0.00	+ 0.05		
	ANGULAR ± 0.5 DEGREE		
 3RD ANGLE PROJECTION		DRAWN : W DAGLISH	
 DO NOT SCALE IF IN DOUBT ASK		CAD SCALE : 1/10	
		DRG.NO. DD900	
		SHEET 3 OF 3	

CONTROLS
SCALE 1/3

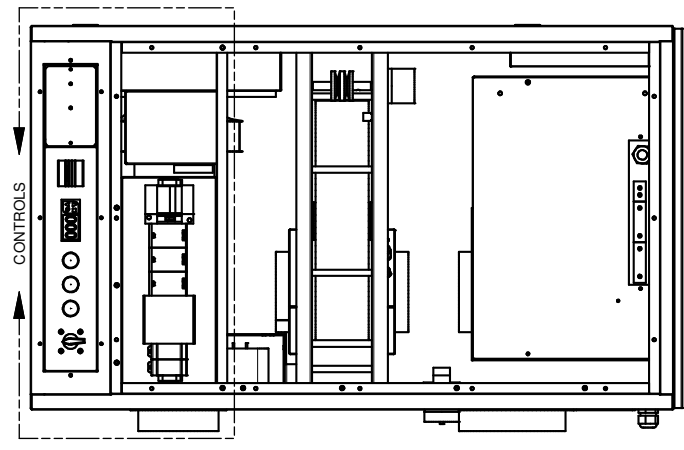

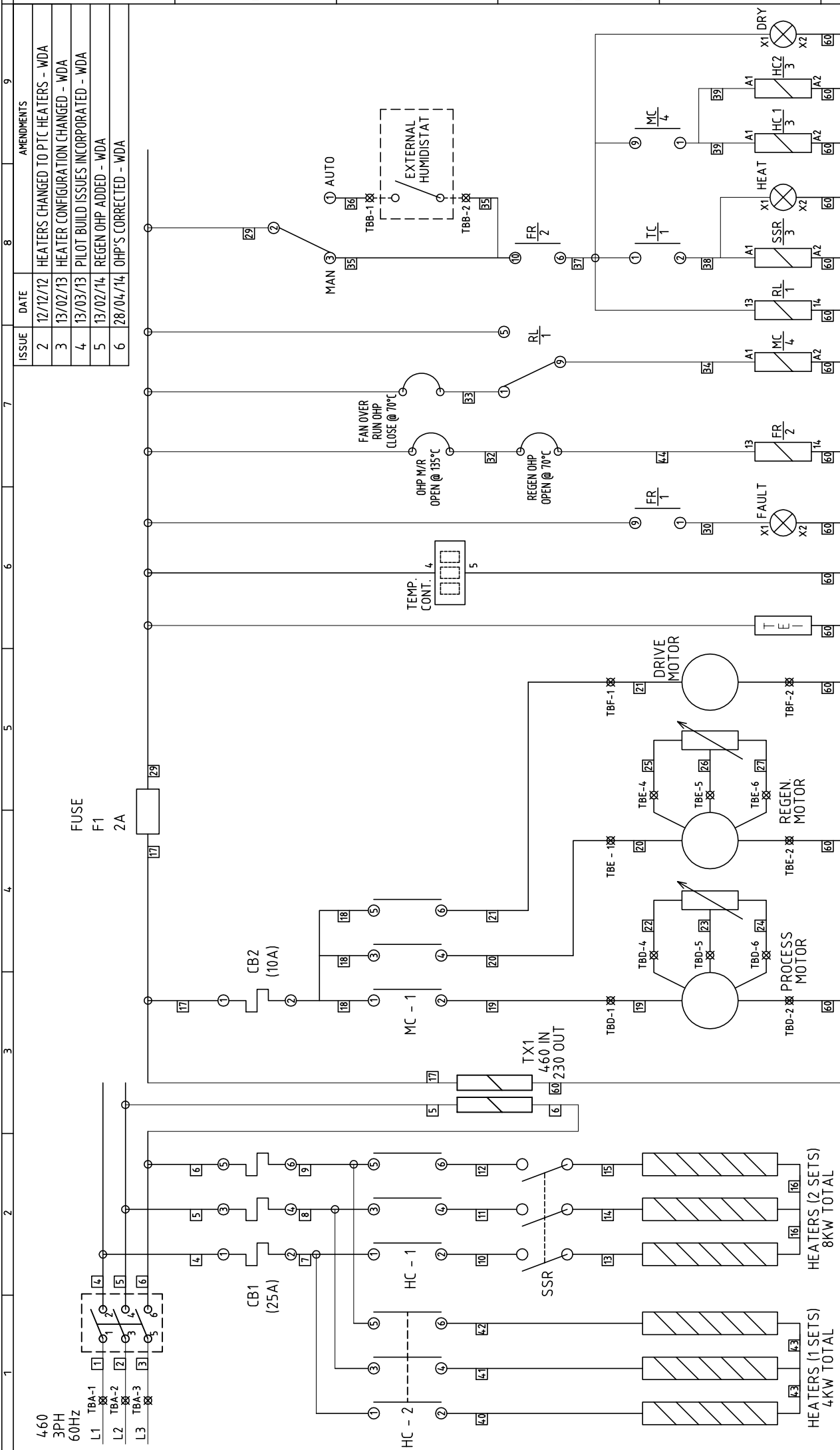

ISSUE	DATE	AMENDMENTS
2	12/12/12	HEATERS CHANGED TO PTC HEATERS - WDA
3	13/02/13	HEATER CONFIGURATION CHANGED - WDA
4	13/03/13	PILOT BUILD ISSUES INCORPORATED - WDA
5	13/02/14	REGEN OHP ADDED - WDA
6	28/04/14	OHP'S CORRECTED - WDA

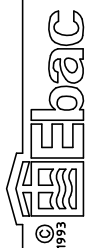

TITLE		DD900 - 460V/60Hz 3PH - WIRING SCHEMATIC	
MATERIAL		N/A	
DIMENSIONS IN m.m.		DRAWN : W DAGLISH	
TOLERANCES UNLESS OTHERWISE STATED		CAD SCALE : N/A	
0.0 ± 1		DRG.NO. 5020325	
0.00 ± 0.25		SHEET 1 OF 1	
0.05 ± 0.05			
ANGULAR ± 0.5 DEGREE			

3RD ANGLE PROJECTION

DO NOT SCALE
IF IN DOUBT ASK

ISSUE	DATE	AMENDMENTS
8	06/05/14	MAINS INLET PLATE EARTH ADDED - WDA
9	10/11/14	NEUTRALS RE-ARRANGED TO HELP PRODUCTION - WDA
10	01/05/15	CONTROL BOX VIEW CHANGED - WDA
11	12/05/15	CONTROL BOX VIEW CHANGED - WDA
12	06/11/15	REGEN FAN T/B VIEW UPDATED - WDA

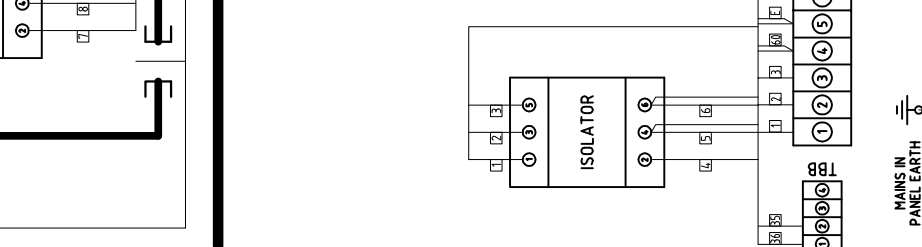
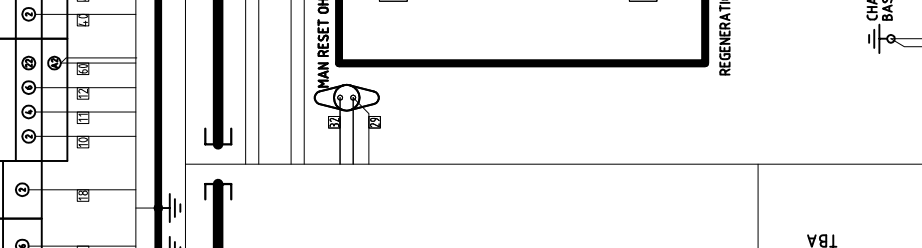
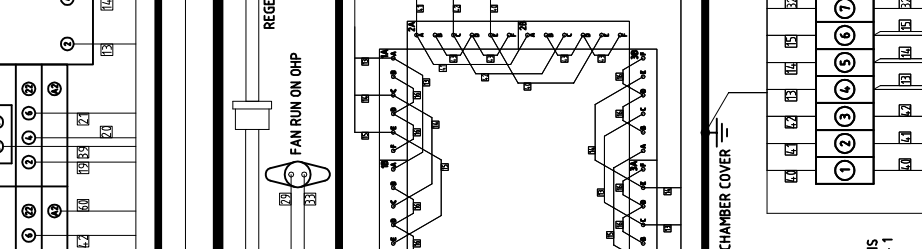
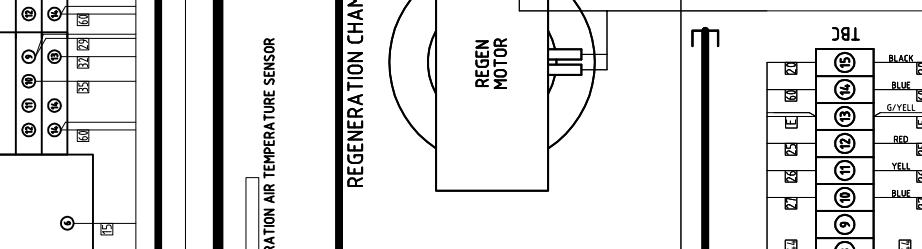
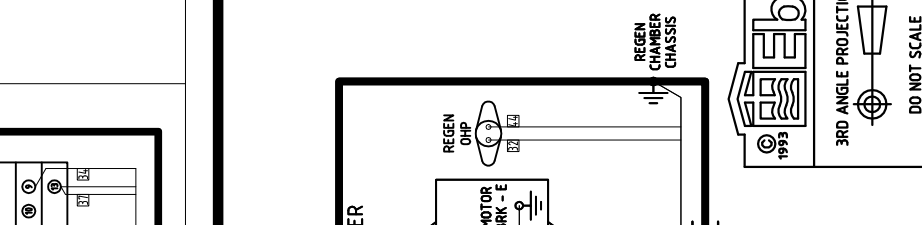
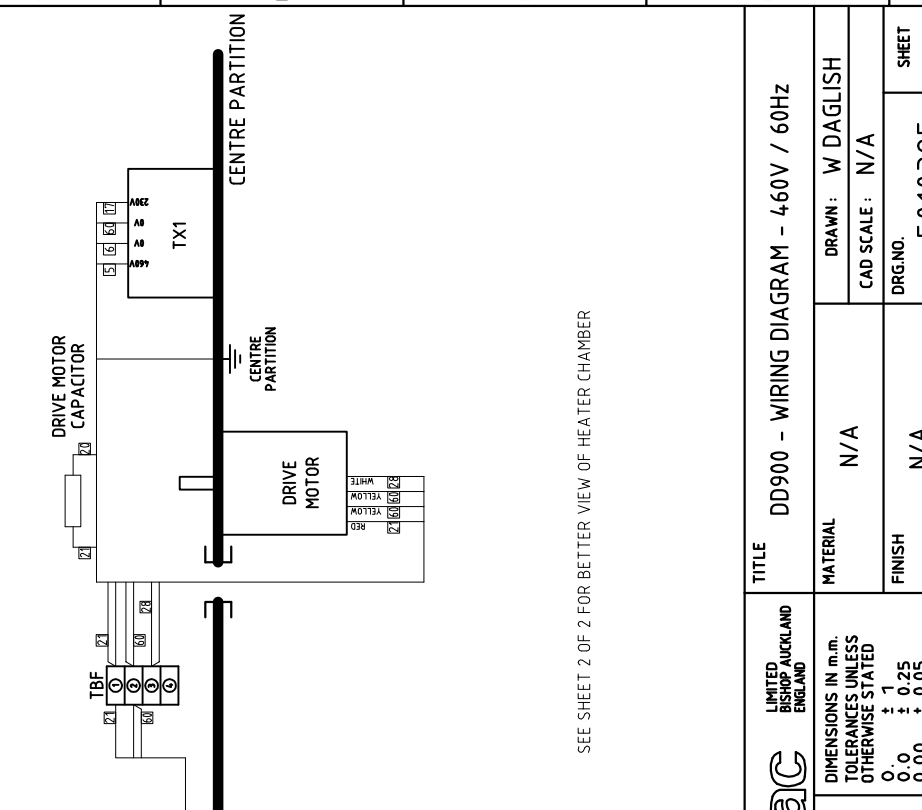
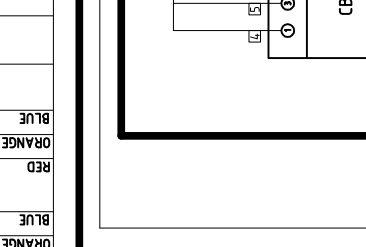
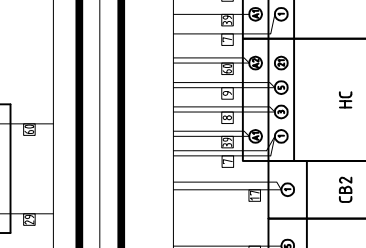
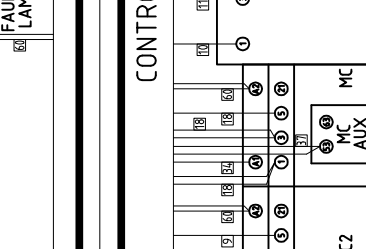
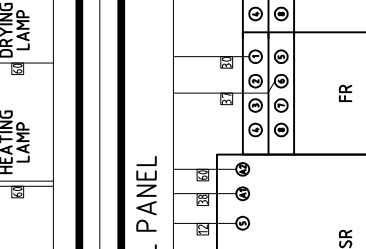
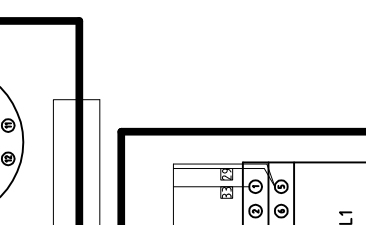
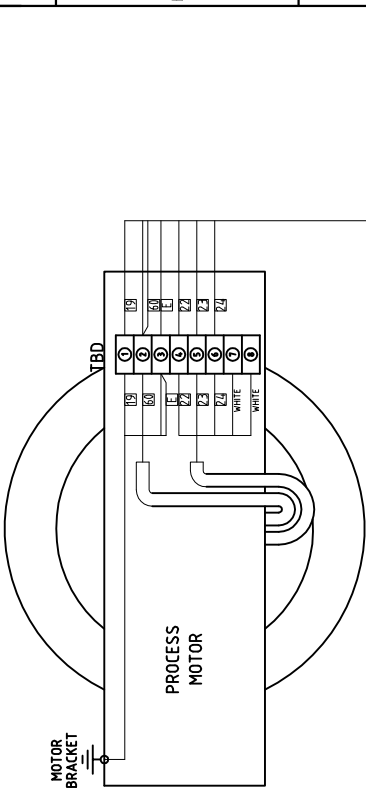
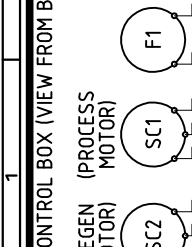
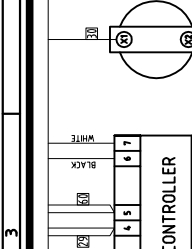
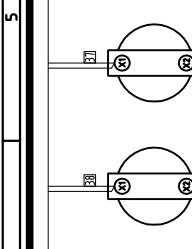
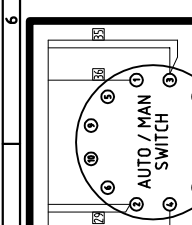
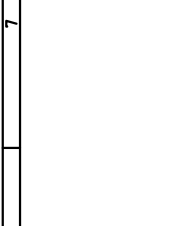

SEE SHEET 2 OF 2 FOR BETTER VIEW OF HEATER CHAMBER

		TITLE DD900 - WIRING DIAGRAM - 460V / 60HZ	
LIMITED BUSHP, AUCKLAND ENGLAND		MATERIAL N/A	
DIMENSIONS IN m.m. TOLERANCES UNLESS OTHERWISE STATED ± 1 0.00 ± 0.25 0.00 ± 0.05 ANGULAR ± 0.5 DEGREE		DRAWN: W DAGLISH CAD SCALE: N/A	
3RD ANGLE PROJECTION DO NOT SCALE IF IN DOUBT ASK		FINISH N/A	
		DRG.NO. 5010325	
		SHEET 1 OF 2	

ISSUE	DATE	AMENDMENTS
8	06/05/14	MAINS INLET PLATE EARTH ADDED - WDA
9	10/11/14	NEUTRALS RE-ARRANGED TO HELP PRODUCTION - WDA
10	01/05/15	CONTROL BOX VIEW CHANGED - WDA
11	12/05/15	CONTROL BOX VIEW CHANGED - WDA
12	06/11/15	REGEN FAN T/B VIEW UPDATED - WDA

ISSUE	DATE	AMENDMENTS
8	06/05/14	MAINS INLET PLATE EARTH ADDED - WDA
9	10/11/14	NEUTRALS RE-ARRANGED TO HELP PRODUCTION - WDA
10	01/05/15	CONTROL BOX VIEW CHANGED - WDA
11	12/05/15	CONTROL BOX VIEW CHANGED - WDA
12	06/11/15	REGEN FAN T/B VIEW UPDATED - WDA

ISSUE	DATE	AMENDMENTS
8	06/05/14	MAINS INLET PLATE EARTH ADDED - WDA
9	10/11/14	NEUTRALS RE-ARRANGED TO HELP PRODUCTION - WDA
10	01/05/15	CONTROL BOX VIEW CHANGED - WDA
11	12/05/15	CONTROL BOX VIEW CHANGED - WDA
12	06/11/15	REGEN FAN T/B VIEW UPDATED - WDA

ISSUE	DATE	AMENDMENTS
8	06/05/14	MAINS INLET PLATE EARTH ADDED - WDA
9	10/11/14	NEUTRALS RE-ARRANGED TO HELP PRODUCTION - WDA
10	01/05/15	CONTROL BOX VIEW CHANGED - WDA
11	12/05/15	CONTROL BOX VIEW CHANGED - WDA
12	06/11/15	REGEN FAN T/B VIEW UPDATED - WDA

ISSUE	DATE	AMENDMENTS
8	06/05/14	MAINS INLET PLATE EARTH ADDED - WDA
9	10/11/14	NEUTRALS RE-ARRANGED TO HELP PRODUCTION - WDA
10	01/05/15	CONTROL BOX VIEW CHANGED - WDA
11	12/05/15	CONTROL BOX VIEW CHANGED - WDA
12	06/11/15	REGEN FAN T/B VIEW UPDATED - WDA

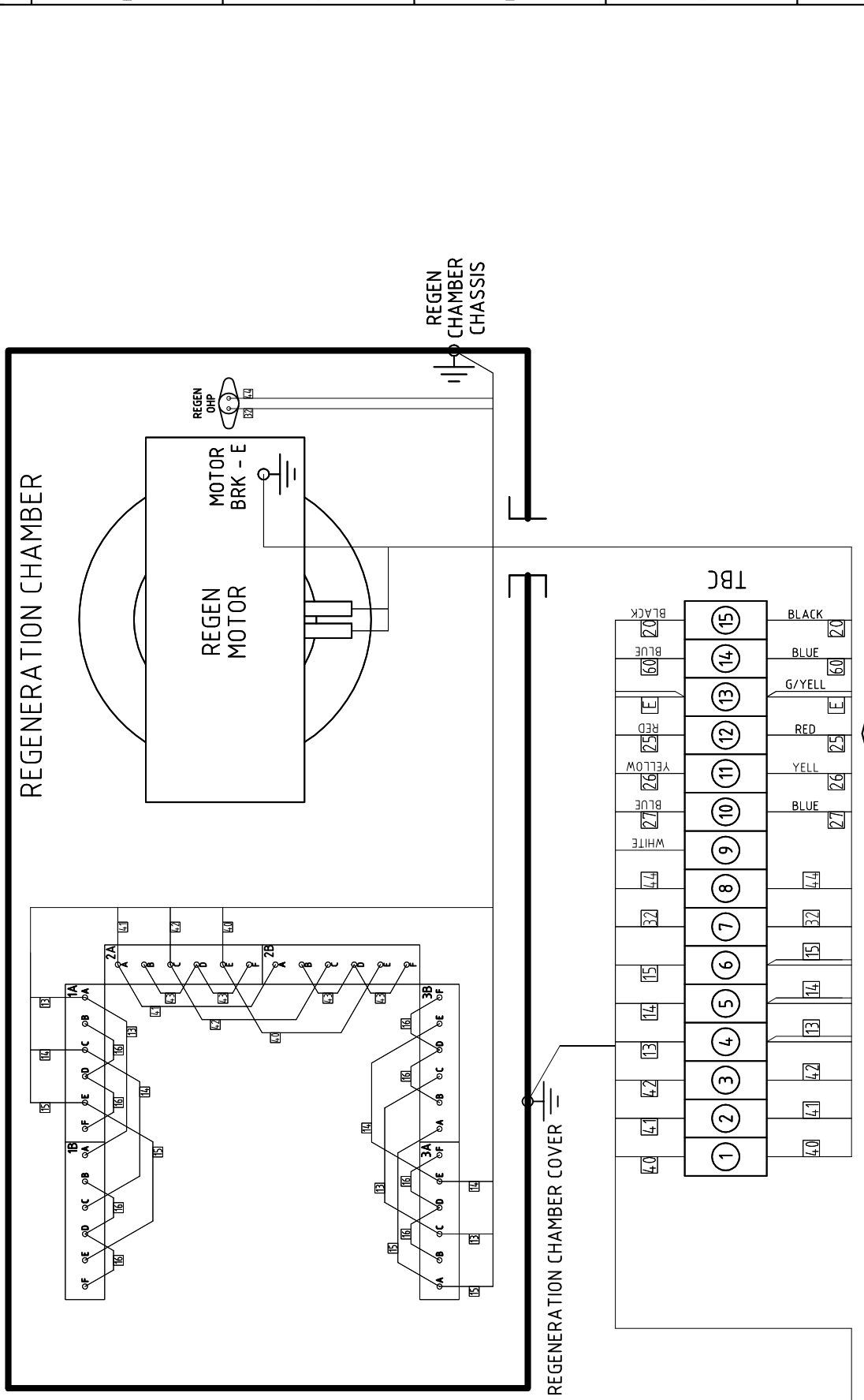

ISSUE	DATE	AMENDMENTS
8	06/05/14	MAINS INLET PLATE EARTH ADDED - WDA
9	10/11/14	NEUTRALS RE-ARRANGED TO HELP PRODUCTION - WDA
10	01/05/15	CONTROL BOX VIEW CHANGED - WDA
11	12/05/15	CONTROL BOX VIEW CHANGED - WDA
12	06/11/15	REGEN FAN T/B VIEW UPDATED - WDA

		LIMITED BISHOP AUCKLAND ENGLAND
1993		
3RD ANGLE PROJECTION		
DO NOT SCALE IF IN DOUBT ASK		
DIMENSIONS IN m.m. TOLERANCES UNLESS OTHERWISE STATED		
± 1 0.00 ± 0.25 0.00 ± 0.05 ANGULAR ± 0.5 DEGREE		

TITLE	DD900 - WIRING DIAGRAM - 460V / 60Hz
MATERIAL	N/A
FINISH	N/A
DRG.NO.	5010325
DRAWN:	W DAGLISH
CAD SCALE:	N/A

SHEET	2 OF 2
-------	--------

ISSUE	DATE	AMENDMENTS
1	26/02/16	ORIGINAL
2	23/03/16	DIGITAL STAT CORRECTED - WDA

HUMIDISTAT 3035157

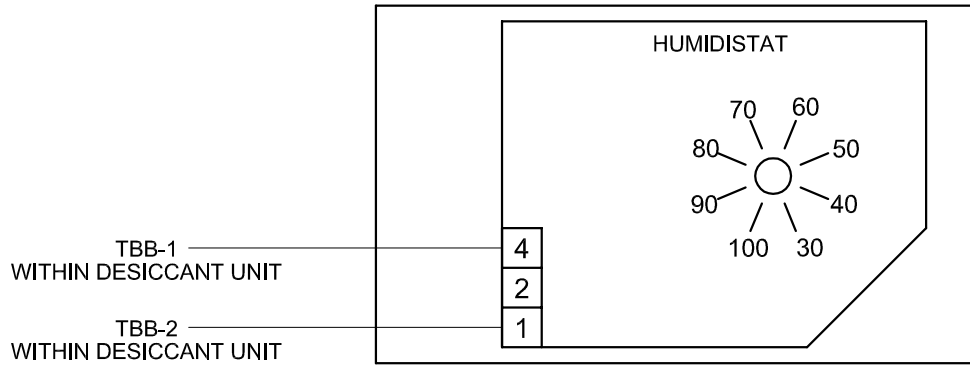

FROM	TERM.	TO	TERM.
H/STAT - 1	PLAIN	TBB-1	SOLDER
H/STAT - 4	PLAIN	TBB-2	SOLDER

- HUMIDISTAT 3035159 - 230V (INTERNAL SENSOR)
- HUMIDISTAT 3035160 - 115V (INTERNAL SENSOR)
- HUMIDISTAT 3035161 - 230V (EXTERNAL SENSOR)
- HUMIDISTAT 3035162 - 115V (EXTERNAL SENSOR)

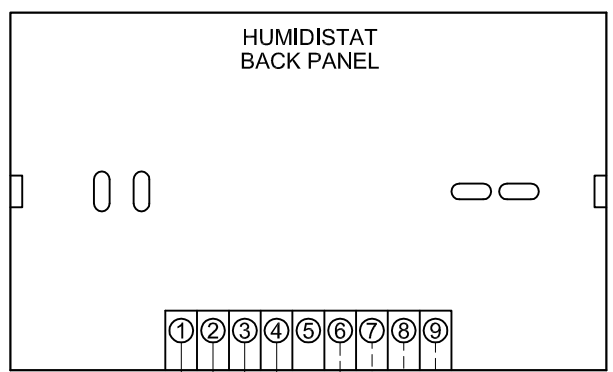

NOTE
ON ALL VERSIONS OF THIS HUMIDISTAT DIP SWITCH 3 MUST BE IN THE 'ON' POSITION. THE DIP SWITCH PANEL IS LOCATED IN THE TOP LEFT CORNER WITHIN THE FRONT PANEL OF THE HUMIDISTAT.

HUMIDISTAT SENSOR
(3035161 / 3035162 ONLY)

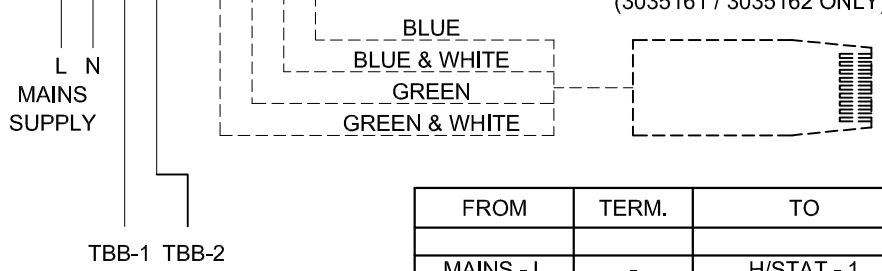

FROM	TERM.	TO	TERM.
MAINS - L	-	H/STAT - 1	PLAIN
MAINS - N	-	H/STAT - 2	PLAIN
H/STAT - 3	PLAIN	TBB-1	SOLDER
H/STAT - 4	PLAIN	TBB-2	SOLDER
H/STAT - 6	PLAIN	SENSOR-GR/WH	-
H/STAT - 7	PLAIN	SENSOR-GR	-
H/STAT - 8	PLAIN	PLUG - BL/WH	-
H/STAT - 9	PLAIN	PLUG - BL	-

© 1993 **Ebac** LIMITED BISHOP AUCKLAND ENGLAND

TITLE **DESICCANT - REMOTE H/STAT WIRING**

3RD ANGLE PROJECTION

 DO NOT SCALE
 IF IN DOUBT ASK

DIMENSIONS IN m.m.
 TOLERANCES UNLESS OTHERWISE STATED
 0. ± 1
 0.0 ± 0.25
 0.00 ± 0.05
 ANGULAR ± 0.5 DEGREE

MATERIAL **N/A**
 FINISH **N/A**

DRAWN: W. DAGLISH
 CAD SCALE: N/A
 DRG.NO. **5010320**
 SHEET 1 OF 1



Drawing	: - TPC 388
Issue	: - 10
Date	: - 24/11/16

UK Head Office

Ebac Industrial Products Ltd
St Helens Trading Estate
Bishop Auckland
County Durham
DL14 9AD

Tel: +44 (0) 1388 664400
Fax: +44 (0) 1388 662590

www.eipl.co.uk
sales@eipl.co.uk

American Sales Office

Ebac Industrial Products Inc
700 Thimble Shoals Blvd.
Suite 109, Newport News
Virginia, 23606-2575
USA

Tel: +01 757 873 6800
Fax: +01 757 873 3632

www.ebacusa.com
sales@ebacusa.com

German Sales Office

Ebac Industrial Products Ltd.
Gartenfelder Str. 29-37
Gebäude 35
D-13599, Berlin
Germany

Tel: +49 3043 557241
Fax: +49 3043 557240

www.eip-ltd.de
sales@eip-ltd.de